

BTB TYPE AUTOMATIC TRANSFER SWITCH (ATS)

Programmable Automatic Transfer Switch Operation Manual



Main Switch Rated Current 2P/3P/4P 100Amp & 250Amp & 2P 400 Amp

Main Switch Rated Voltage 690 Vac

TAIWAN Pat. No. M553490

U.S. Patent Number : 11,239,692

China Patents Pending



KUTAI ELECTRONICS INDUSTRY CO., LTD.

TEL : +886-7-8121771

FAX : +886-7-8121775

Website : www.kutai.com.tw

Headquarters : No.3, Ln. 201, Qianfu St., Qianzhen Dist., Kaohsiung City 806037, Taiwan

ISO 9001
ETC

TABLE OF CONTENTS

Section	Page
SECTION 1 : SAFETY PRECAUTIONS	
SECTION 2 : RECEIVING INSPECTION	
2.1 Model Number Explanation	3
2.2 Contents of Shipping Container.....	3
2.3 Overview of Exterior.....	4
2.4 Dimensions	4
2.5 Operation Buttons And Display Screen	5
2.5.1 Without CTM-25 Module Installation	5
2.5.2 With CTM-25 Module Installation	6
SECTION 3 : INSTALLATION	
3.1 Installation Precautions.....	7
3.2 Recommended Wire Sizes and Torque Values.....	7
3.3 Description of Connection Terminals.....	7
SECTION 4 : SYSTEM PARAMETER SETTINGS	
4.1 Precautions When Connecting Power.....	8
4.2 System Parameter Settings	8
4.3 Screen Saver	8
4.4 System Parameter Settings Table.....	9
SECTION 5 : FUNCTIONAL TEST	
5.1 Functional TEST	11
5.1.1 AUTO Functional Test.....	11
5.1.2 TEST with Load	11
5.1.3 TEST without Load	11
5.2 Manual Transfer Knob	11
5.3 Safety Lock	12
5.4 Power lead terminal	12
SECTION 6 : PRODUCT INTRODUCTION	
6.1 Display Parameters.....	13
6.2 Monitoring Protection.....	13
6.3 Electrical Characteristics	13
6.4 MCCB Rated Current, Rated Breaking Capacity and Weight	13
SECTION 7 : TRIP RESET	
SECTION 8 : OPTIONAL ACCESSORIES	

SECTION 1 : SAFETY PRECAUTIONS

NOTICE	Make sure that all required steps are completed.
⚠ CAUTION	Failure to follow proper procedure may result in permanent damage to the device.
⚠ WARNING	Failure to follow proper procedure may result in personal injury or death.

This manual contains information for the installation, wiring, suitable applications, operation and maintenance of this Automatic Transfer Switch. This manual should be read before operating the device.

⚠ WARNING

Installation, wiring and setting of system parameters for this Automatic Transfer Switch should be done by qualified technical personnel. Improper installation, wiring or system settings may result in personal injury or damage to the equipment.

SECTION 2 : RECEIVING INSPECTION

The product should be inspected immediately after delivery to determine whether any damage has occurred due to collision during shipping. Also check that the product model no., system voltage and the number of poles all match (see table below). If the container or the product is short any items, or damaged, or the model no. does not match the standard then immediately contact our company or the agent you purchased the unit from.

2.1 Model Number Explanation

Product	Types of AC Distribution System	IEC Category		Rated Current	Safety Certification		Applicable Voltages (Vac)		Enclosure		
BTB	3	B	2	X	D		C				
1	1P/3W (3P)	B	Class CB *1	1	100A	U	UL Certified	1	100 / 110 / 120	Blank	No enclosure
2	1P/2W (2P)	P	Class PC *2	2	250A	X	Standard (Not UL)	2	200 / 220 / 240	C	With indoor enclosure
3	3P/3W (3P)			3	400A*3			3	380 / 415	E	With outdoor enclosure
4	3P/4W (4P)							4	440 / 460 / 480		
								D	100 – 480 *4		

*1 Class CB : Provides over current protection. The main contacts are capable of making and breaking short circuit currents.
 *2 Class PC : Able to withstand but not capable of breaking short-circuit current.
 *3 Uses 4P MCCB connected as 2P for 400A load current.
 *4 Requires 9 to 36 VDC power input for control circuit.

⚠ CAUTION

The applicable voltages code of BTB model number should correspond to utility voltage range. Improper BTB voltage specific used will cause malfunction or damage to equipment.

2.2 Contents of Shipping Container

2.2.1 ATS without enclosure : 1. Automatic Transfer Switch (1 set) 2. 5/16” hex key 1 ea.

2.2.2 ATS with enclosure : 1. Automatic Transfer Switch (1 set) 2. 5/16” hex key 1 ea. 3. Enclosure 1 ea. 4. Enclosure mounting hooks 4 ea.

2.3 Overview of Exterior (Figure 1)

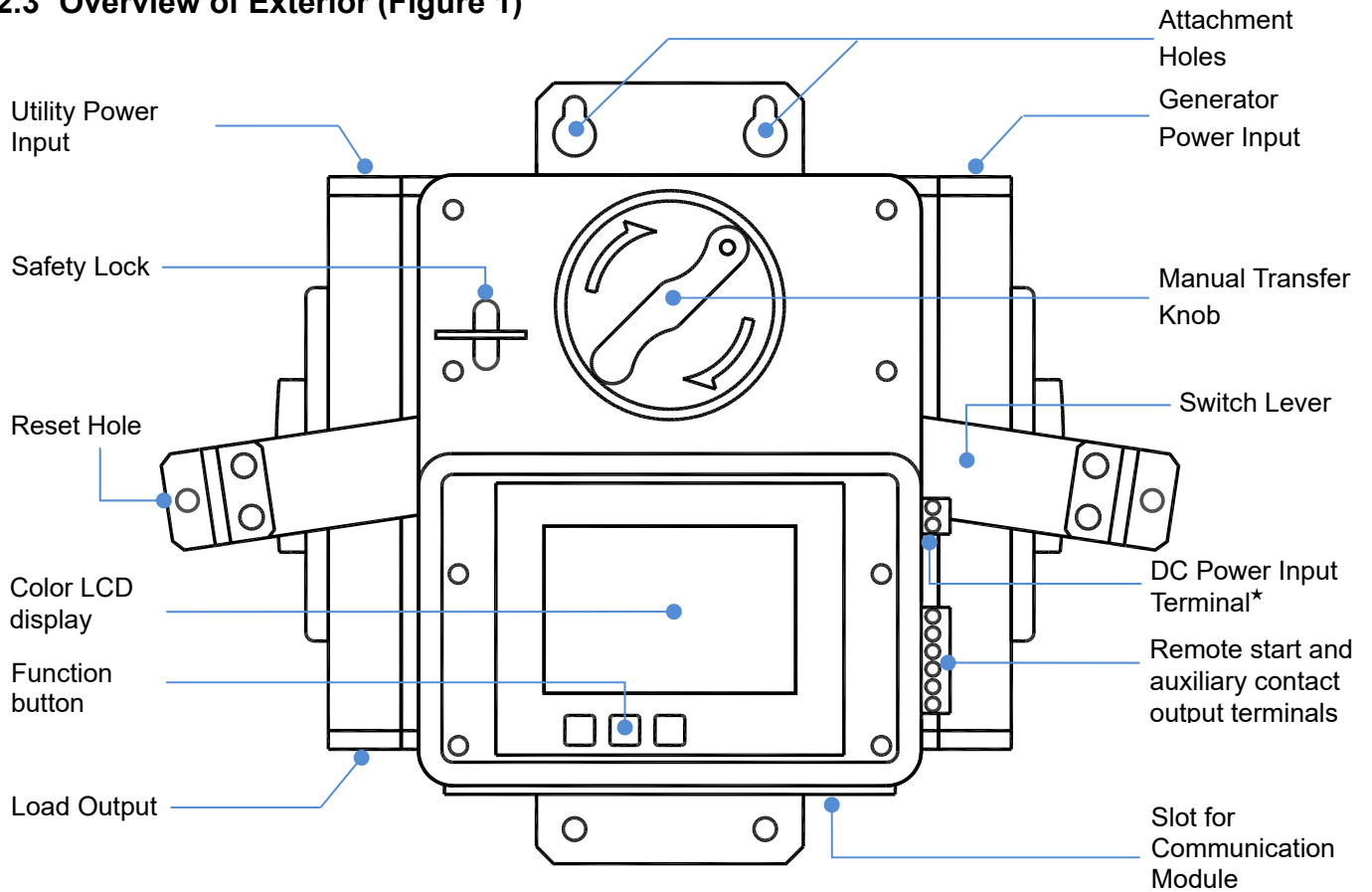

Note : ★ Backup terminal no need for connection except BTBxxxxD



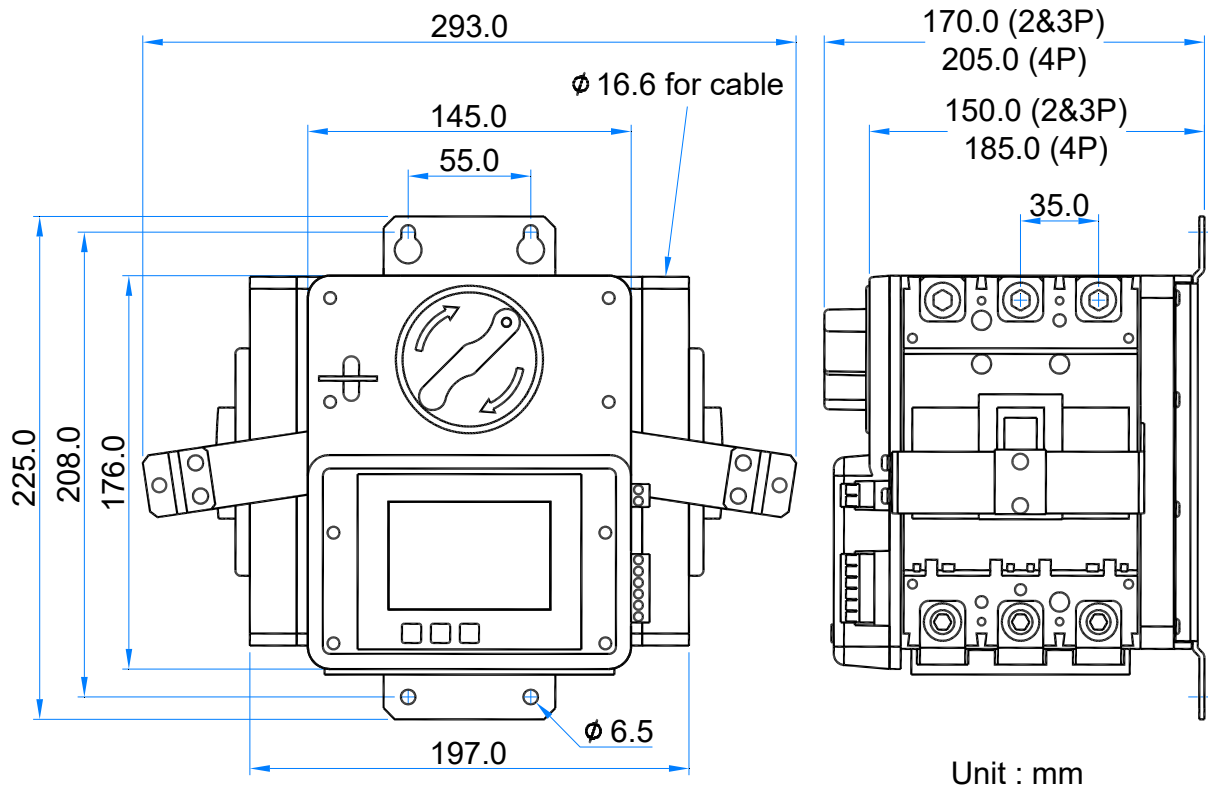



2.4 Dimensions (Figure 2)





2.5 Operation Buttons and Display Screen

2.5.1 Without CTM-25 Module Installation







Utility Power Status

-  No power and switch not closed
-  Power ready but switch not closed
-  No power but switch is closed
-  Power ready and switch closed
-  Transfer failure
-  Switch has Tripped

Load Status

-  Power to Load
-  No power to Load





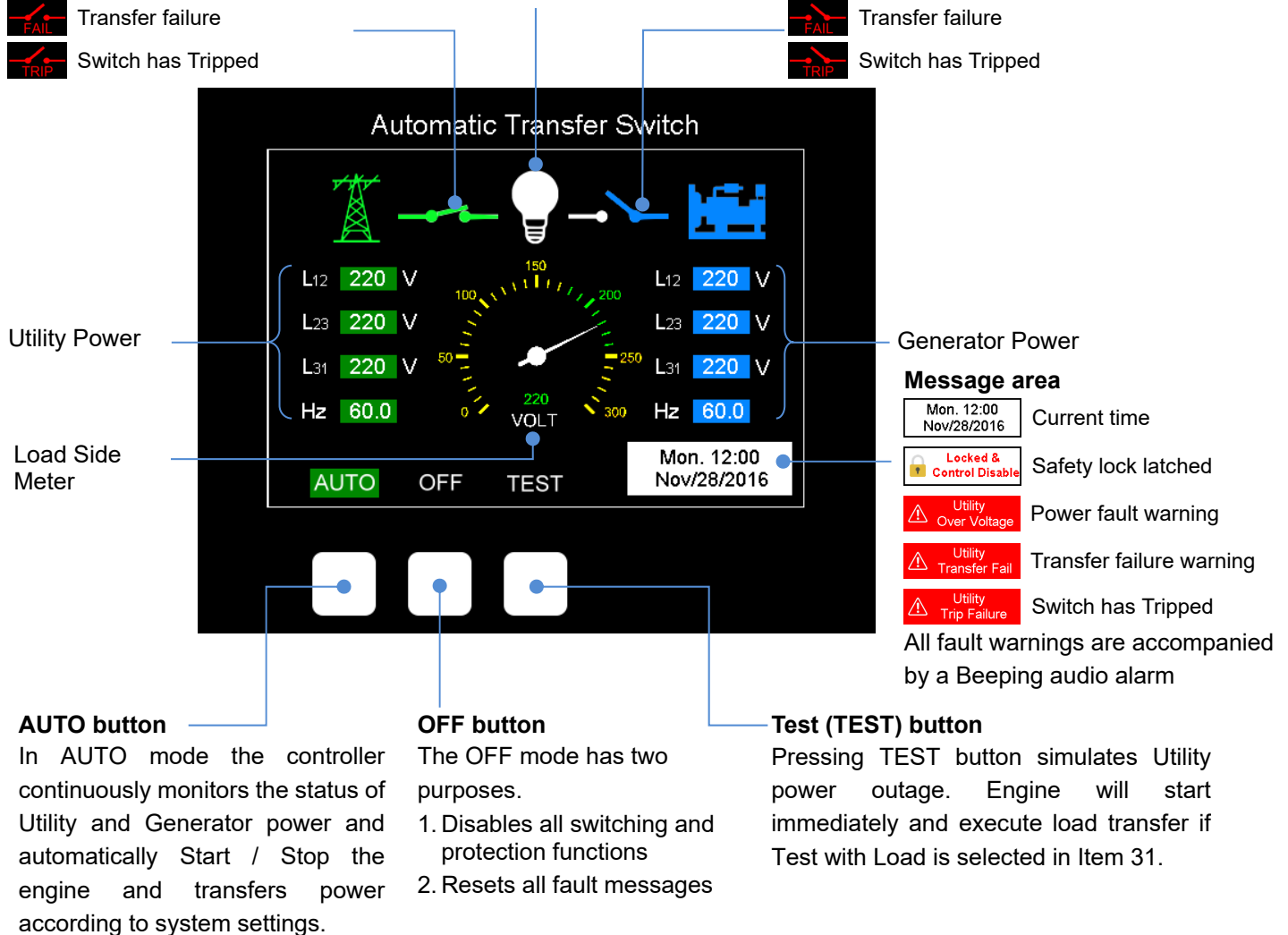

Generator Power Status

-  No power and switch not closed
-  Power ready but switch not closed
-  No power but switch is closed
-  Power ready and switch closed
-  Transfer failure
-  Switch has Tripped





2.5.2 With CTM-25 Module Installation







Utility Power Status

-  No power and switch not closed
-  Power ready but switch not closed
-  No power but switch is closed
-  Power ready and switch closed
-  Transfer failure
-  Switch has Tripped

Load Status

-  Power to Load
-  No power to Load

Generator Power Status

-  No power and switch not closed
-  Power ready but switch not closed
-  No power but switch is closed
-  Power ready and switch closed
-  Transfer failure
-  Switch has Tripped

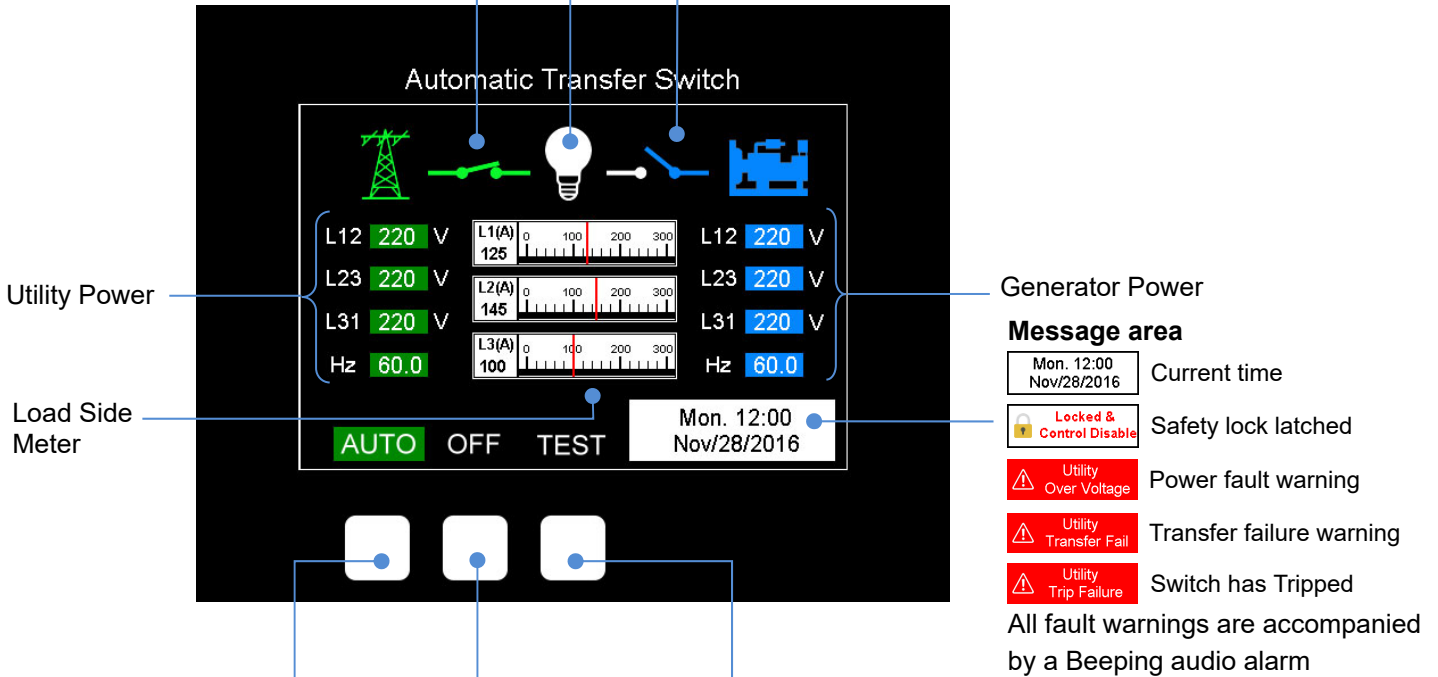

AUTO button

In AUTO mode the controller continuously monitors the status of Utility and Generator power and automatically Start / Stop the engine and transfers power according to system settings.

OFF button

The OFF mode has two purposes.

1. Disables all switching and protection functions
2. Resets all fault messages

Test (TEST) button

Pressing TEST button simulates Utility power outage. Engine will start immediately and execute load transfer if Test with Load is selected in Item 31.

SECTION 3 : INSTALLATION

3.1 Installation Precautions (Figure 3)

1. When connecting power cables to the Automatic Transfer Switch reserve room for action of the transfer switch lever (Distance $\geq 80\text{mm}$) to avoid hindering the action of the lever and preventing the switch from operating normally. All power cables should be fixed to the housing with tie straps.
2. The phase sequence of the Utility and Generator power must be the same to prevent reversal of operation of 3-phase motors.

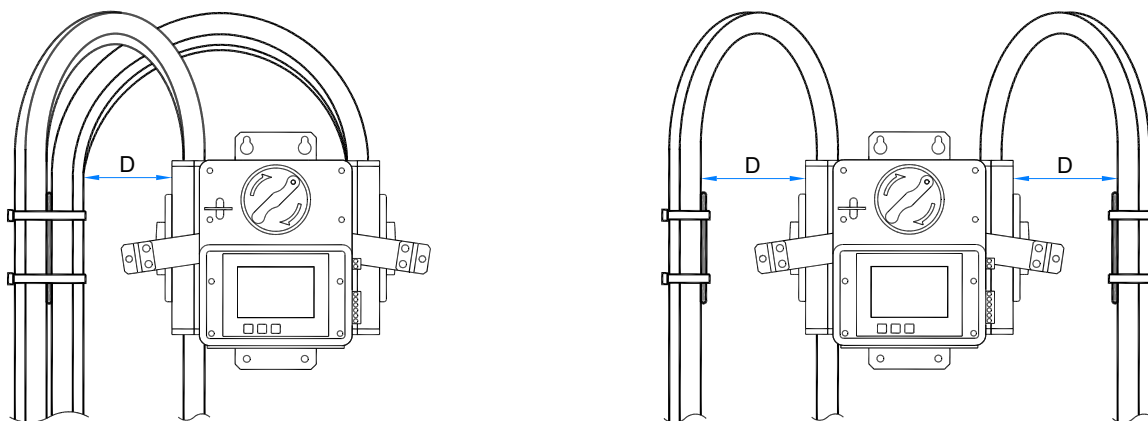

3.2 Recommended Cable Sizes and Torque Values

Cable Size and Recommended Torque			
Rated Current (A)	Cable Size	Torque	Expose conductor
125	1 AWG (42.4 mm ²)	204 lb-in (23 N-m)	
150	1/0 AWG (53.5 mm ²)		
175	2/0 AWG (67.4 mm ²)		
200	3/0 AWG (85.0 mm ²)		
225	4/0 AWG (107.2 mm ²)		
250	250 MCM (127 mm ²)		

3.3 Description of Connection Terminals

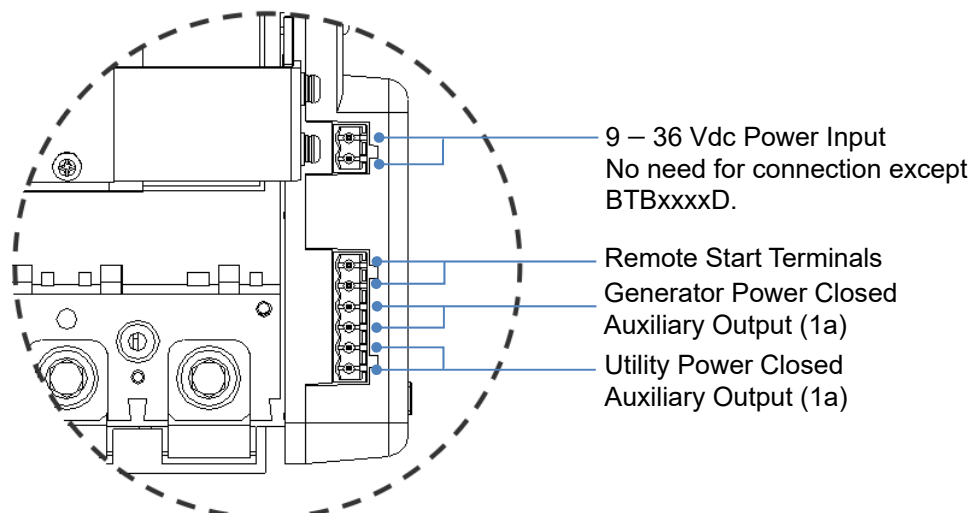

SECTION 4 : SYSTEM PARAMETER SETTINGS

4.1 Precautions when Connecting Power

Either Utility or Generator power supply is required to execute system parameter settings.

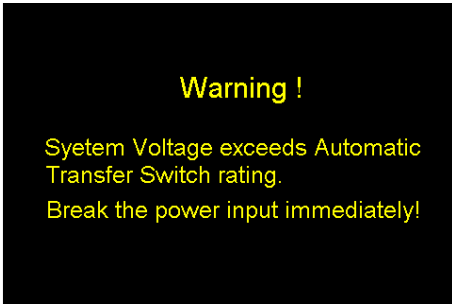

⚠ CAUTION

This screen indicates that the input voltage is too high and all power should be turned off immediately.

4.2 System Parameter Settings

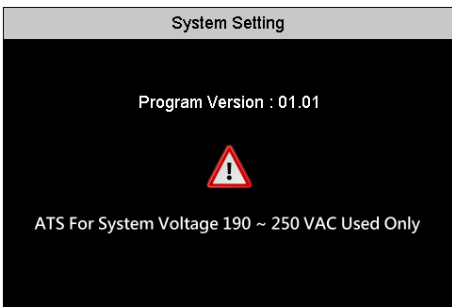

⚠ CAUTION

All parameters of the ATS can be set directly from the operator panel. To enter setting mode press and hold **OFF** for 4 seconds until the program version screen appears. See the screen at left side.

System Setting	
01- System Phase Setting	3 P
Adjustment : Single Phase (1P) / Three Phase (3P)	
02- TDEN Time Delay Emergency to Normal	10 sec
03- TDNE Time Delay Normal to Emergency	10 sec
04- TDES Time Delay Engine Start	05 sec
05- TDEC Time Delay Engine Cool-Down	30 sec
06- TDOF Time Delay in the OFF Position	05 sec
07- Normal Over Voltage Protection	250 V
08- Normal Under Voltage Protection	180 V

Navigation icons: Up arrow, ENTER, Down arrow.

Use the **▲** and **▼** keys to change setting value. Press the **▲** or **▼** key to increase or decrease the setting value by 1 unit. If you hold down the **▲** or **▼** key the setting value will increase or decrease continuously until the built-in limit is reached. After completing the individual settings, press **ENTER** to save the setting and skip to the next line. For the factory settings of each parameter refer to Table.4.4.

Green highlight represents the current setting Black highlight indicates setting range.

The following three ways will end setting mode and return to normal operation.

1. Press **ENTER** repeatedly until the last setting item is reached.
2. Press and hold **ENTER** for 4 seconds
3. No button is touched for 60 seconds

4.3 Screen Saver

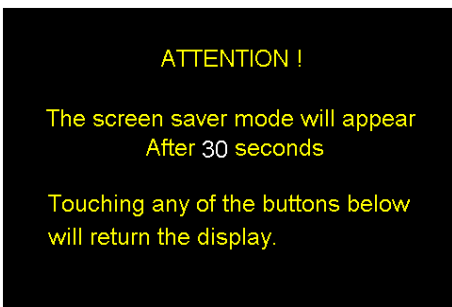

NOTICE

If the switch is not touched for 30 minutes the system will enter the screen saver countdown screen. Touch any button below to re-wake the screen or end the countdown screen. If there are any changes in status or faults power the screen will wake up automatically.

4.4 System Parameter Settings Table

LINE	DESCRIPTION	Setting Range	FACTORY SETTING
01	Language / Idioma / 语言 / 言語	English / Español / 繁体中文 / 日本語	English
02	System Phase	Single phase (1P) or 3-phase (3P)	3P
03	TDEN Time Delay Emergency to Normal	0 – 999 sec.	10 sec
04	TDNE Time Delay Normal to Emergency	0 – 250 sec.	10 sec
05	TDES Time Delay Engine Start	0 – 15 sec.	05 sec
06	TDEC Time Delay Engine Cool-down	0 – 250 sec.	30 sec
07	TDOF Time Delay in the OFF Position	0 – 99 sec.	05 sec.
08	Utility side over voltage protection	BTBxxxx 1 : 110 – 150 Vac	130V
		BTBxxxx 2 : 210 – 290 Vac	250V
		BTBxxxx 3 : 390 – 490 Vac	420V
		BTBxxxx 4 : 450 – 530 Vac	480V
		BTBxxxx D : 110 – 530 Vac	250V
09	Utility under voltage protection	BTBxxxx 1 : 80 – 110 Vac	90V
		BTBxxxx 2 : 160 – 230 Vac	190V
		BTBxxxx 3 : 300 – 410 Vac	340V
		BTBxxxx 4 : 350 – 470 Vac	400V
		BTBxxxx D : 80 – 470 Vac	180V
10	Delay to confirm fault with Utility voltage	00 – 99 sec (0 : no voltage protection function)	1sec
11	Utility over frequency protection	51 – 75 Hz	65 Hz
12	Utility under frequency protection	40 – 59 Hz	55 Hz
13	Delay to confirm fault with Utility frequency	00 – 99 sec. (0 : no frequency protection function)	1 sec
14	Generator over voltage protection	BTBxxxx 1 : 110 – 150 Vac	130V
		BTBxxxx 2 : 210 – 290 Vac	250V
		BTBxxxx 3 : 390 – 490 Vac	420V
		BTBxxxx 4 : 450 – 530 Vac	480V
		BTBxxxx D : 110 – 530 Vac	250V
15	Generator under voltage protection	BTBxxxx 1 : 80 – 110 Vac	90V
		BTBxxxx 2 : 160 – 230 Vac	190V
		BTBxxxx 3 : 300 – 410 Vac	340V
		BTBxxxx 4 : 350 – 470 Vac	400V
		BTBxxxx D : 80 – 470 Vac	180V
16	Delay to confirm fault with Generator voltage	0 – 99 sec. (0 : indicates no voltage protection function)	1sec
17	Generator over frequency protection	51 – 75 Hz	65 Hz
18	Generator under frequency protection	40 – 59 Hz	55 Hz
19	Delay to confirm fault with Generator frequency	0 – 99 sec. (0 : indicates no frequency protection function)	1 sec
20	Set current time – Year	2017 – 2099	Current

LINE	DESCRIPTION	VALUE	FACTORY SETTING
21	Set current time – Month	01 – 12	Current
22	Set current time – Day of Month	01 – 31	Current
23	Set current time – Day of Week	Monday – Sunday	Current
24	Set current time – Hour	00 – 23 (24 hour system)	Current
25	Set current time – Minute	00 – 59	Current
26	Set automatic exercise time – Day of Week	Monday – Sunday	Saturday
27	Set automatic exercise time – Hour	00 – 23 (24 hour system)	12
28	Generator exercise time interval	1 – 4 weeks	1 week
29	Duration of exercise	00 – 99 minutes (00 : indicates no automatic exercise time function)	0
30	Exercise test with load or without load?	With Load or Without Load	Without load
31	Manual test with load or without load?	With Load or Without Load	With load
32	Gauge display	Voltage (V) or Frequency (Hz)	V
33	Remote control by KCU-XX Module	Enabled or Disabled	Disabled
34	KCU-05 or KCU-07 Module address	0 – 99 (0=KCU module restricted)	0
35	KCU-05 Module baud rate	2400/4800/9600/14400/19200/38400/ 57600/115200	38400
36	KCU-05 module parity check	N81/N82/E81/O81	N81
37	Screen brightness	1 – 10	8
38	Execute voltage reading calibration?	Yes or No	No
39	Restore factory settings?	Yes or No	No
40	Read or delete event logs?	No or Read or Delete	No
41	Current Meter Setting	100A/150A/200A/250A/300A/350A/400A/450A	300A
42	Firmware update?	Yes or No	No
43	Unbind device?	Yes or No	No

※ Programming lines 42 and 43 are displayed only when the controller is successfully connected to KUTAI server for more than 90 seconds.

SECTION 5 : FUNCTIONAL TEST

5.1 Functional TEST

After wiring and system settings are completed, the user should perform (AUTO) and (TEST)

5.1.1 AUTO Functional Test

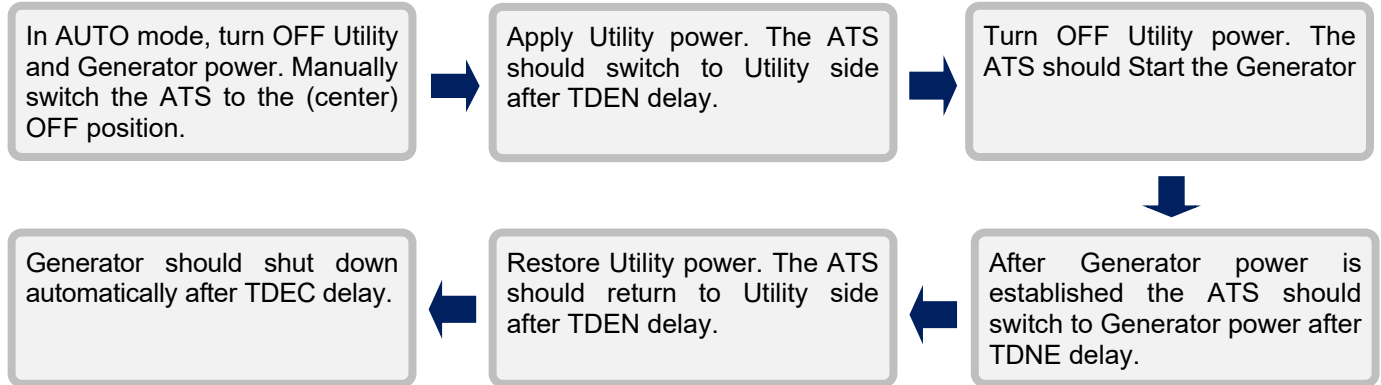

5.1.2 TEST with Load

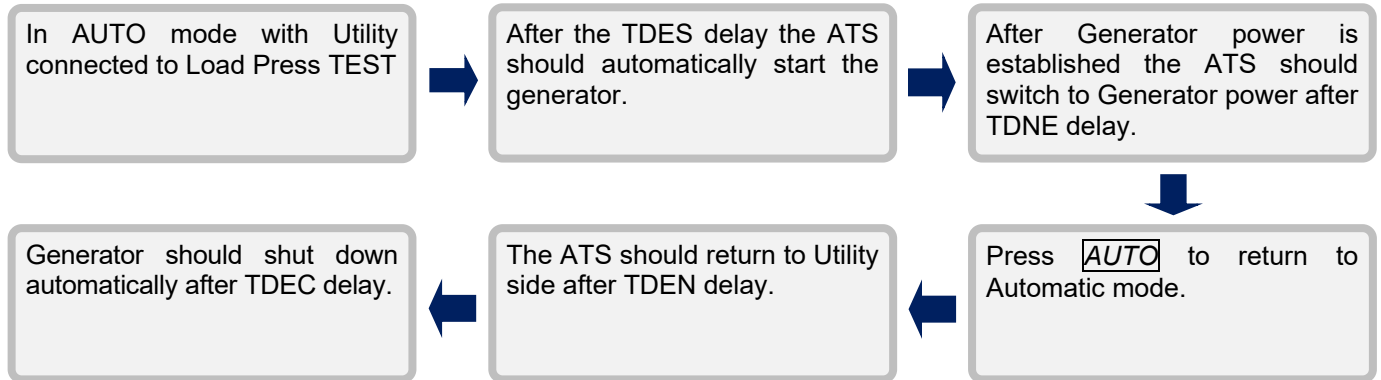

5.1.3 TEST without Load

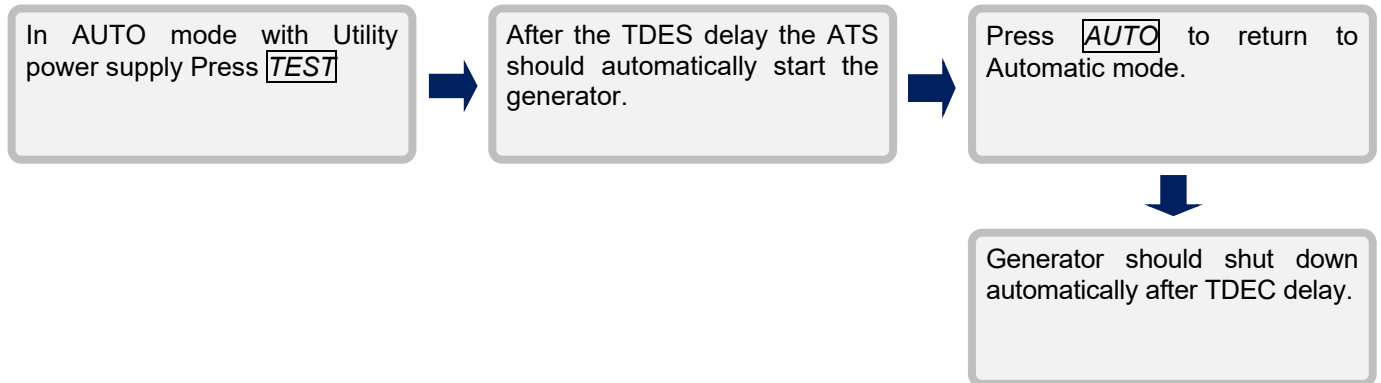

5.2 Manual Transfer Knob

The Manual Transfer Knob turns only in clockwise direction to force transfer of the switch position – unless in AUTO mode and status of power inputs changes.

5.3 Safety Lock

The Safety Lock is an override device. Once it is locked the following functions will become ineffective.

1. The manual operation handle will not operate and the switch will be held in current position.
2. All protection functions and panel buttons on the controller will be disabled.

Refer to the drawings below :

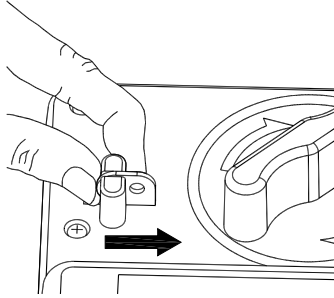

Step 1 : Push the safety lock inward

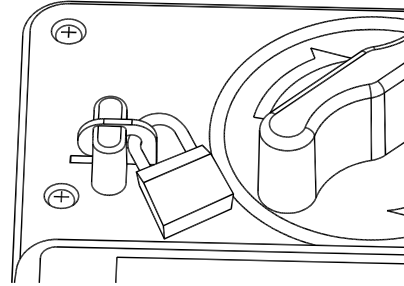

Step 2 : Use a padlock to secure the lock in a closed position

5.4 Power lead terminal

The BTB power lead terminal is mainly used for adding the power lead of electrical equipment, the assembly method is shown in below figure.

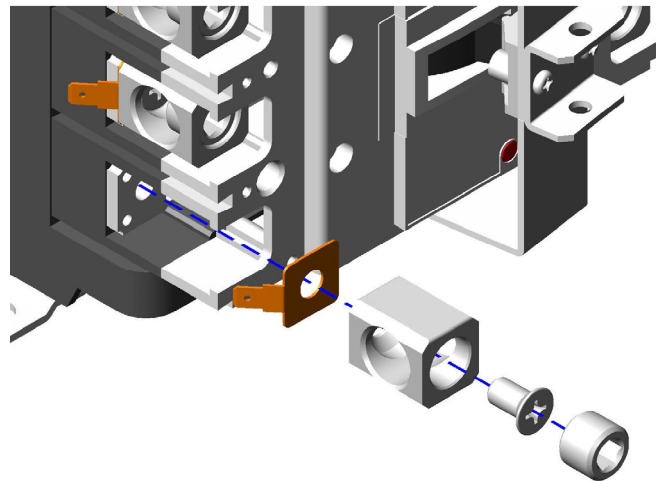

⚠ CAUTION

1. The locking torque between the US standard terminal (LUG) of the main wiring and the copper busbar is 25 N-m. The temperature in full-load will rise too high if the locking torque is insufficient, this may cause abnormal tripping or damage the ATS equipment.
2. The rated current of lead terminal is 5A.
3. No need to install the lead terminal if there is no demand for additional power leads.

SECTION 6 : PRODUCT INTRODUCTION

6.1 Display Parameters

- Graphic display of switch status
- Utility power All Phase Voltage and Frequency
- Generator power All Phase Voltage and Frequency
- Analog meter for load side voltage or frequency
- Fault Message and Warning Display

6.2 Monitoring Protection

- Utility power All Phase Over/Under Voltage and Loss of Phase Protection
- Generator power All Phase Over/Under Voltage and Loss of Phase Protection
- Utility power Over / Under Frequency Protection
- Generator power Over/Under Frequency Protection
- Transfer Failure Warning
- Breaker Tripped Warning (Class CB only)

6.3 Electrical Characteristics

ITEM	SPECIFICATION
Operating Voltage	Refer to Model No.
AC Power Frequency	50/60 Hz
Remote Start Terminals capacity	7 Amp @ 250 Vac Max.
Utility power auxiliary contact capacity	3 Amp @ 250 Vac Max.
Generator power auxiliary contact capacity	3 Amp @ 250 Vac Max.
TDNE Time Delay Normal to Emergency	0 – 250 seconds
TDES Time Delay Engine Start	0 – 15 seconds
TDEN Time Delay Emergency to Utility	0 – 999 seconds
TDEC Time Delay Engine Cool-down	0 – 250 seconds
TDOF Time Delay in the OFF Position	0 – 99 seconds
Static Power Consumption	Below 3W
Operating Temperature	-20 to +60 °C
Relative Humidity	Below 90%

6.4 MCCB Rated Current, Rated Breaking Capacity and Weight

MCCB Rated Current, Rated Breaking Capacity and Weight							
No. of Poles	Rated Insulation Voltage U_i (V)	Rated Current (A) Ambient Temperature 40 °C	Rated Breaking Capacity IEC 60947-2 I_{cu} / I_{cs} (KA)				Weight (KG)
			220/240 V	380/415 V	440 V	550 V	
2P	690	100 / 250	50/25	30/15	25/13	20/10	5.1 Kg \pm 2%
3P	690	100 / 250	50/25	30/15	25/13	20/10	5.6 Kg \pm 2%
4P	690	100 / 250	50/25	30/15	25/13	20/10	6.8 Kg \pm 2%
2P	690	400	50/25	30/15	25/13	20/10	7.0 Kg \pm 2%

SECTION 7 : TRIP RESET (Class CB only)

When an MCCB trips because of overload or short-circuit, it will not automatically reset. Engineering personnel must remove the cause of failure then perform the steps below to reset the tripped MCCB.

⚠ WARNING

Both Utility and Generator power must be OFF before executing trip reset. Working with live electricity will present an electric shock hazard that could lead to serious injury to personnel.

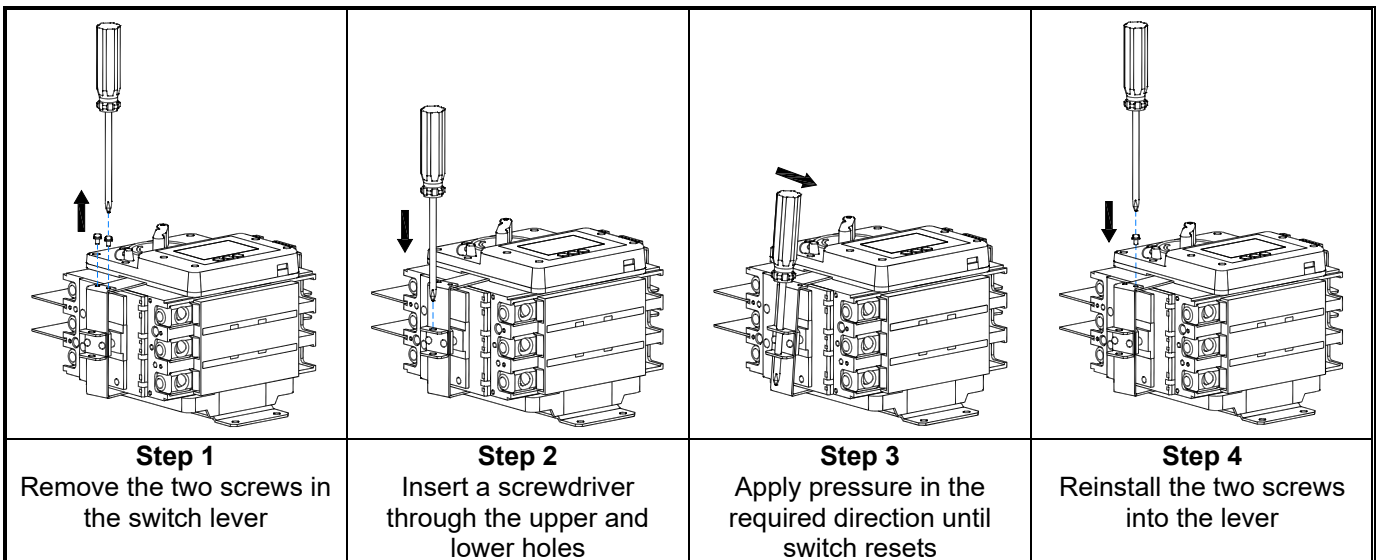

SECTION 8 : OPTIONAL ACCESSORIES

1. Modbus-RTU communication module (KCU-05) Refer to KCU-05 User Manual for installation instructions.
2. Modbus-TCP communication module (KCU-07) Refer to KCU-07 User Manual for installation instructions.
3. SNMP communication module (KCU-06) Refer to KCU-06 User Manual for installation instructions.
4. Ethernet (Dynamic IP) Communication Module (KCU-31) Refer to KCU-31 User Manual for installation instructions.
5. Wi-Fi Communication Module (KCU-41) Refer to KCU-41 User Manual for installation instructions.
6. KCU communication module cable (1 meter).
7. CTM-25 current transformer (CT) & Communication Module.

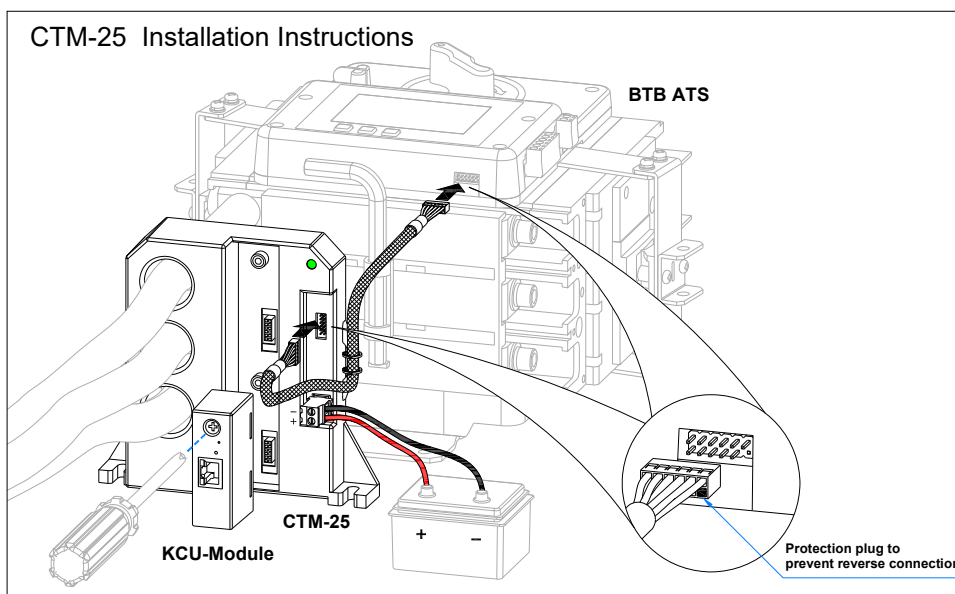

⚠ WARNING

When an optional communication module is used with the Automatic Transfer Switch can enable remote control and monitoring of ATS status and also start the generator unit. When using a remote communication module it is necessary to follow the instructions below, otherwise it could lead to injury to personnel or death :

1. The generator should be surrounded by a protective fence.
2. A permanent warning sign must be posted clearly to alert personnel. The warning sign should convey that “Generator could start at any time”.
3. When servicing or working around the ATS or generator the ATS safety lock should be latched and the generator controller in the (OFF) mode to ensure the safety of personnel.

NOTICE

It is recommended to use the battery to provide operating power to remote communication modules connected to the BTBxxxxD type ATS to avoid the situations where the remote communication function is lost because the Utility power supply has been cut off but the standby generator set has not yet started.